

<p>Duobinary coder VWA-28-DUO-SD</p>
<p>10 – 28 Gb/s</p>

Description

The **VWA 50029 AA** chip is a duobinary coder for high data rate application, typically 10 to 25 (tbc) Gb/s. The chip is designed in 0.18µm SiGe BiCMOS 150 GHz process.

The device has two high frequency differential inputs (NRZ_in and Clock) and one differential high frequency output (Duobinary_Out). The chip is 50Ω single ended and 100Ω differential in and out. The chip can be used single in and out.

The input data stream is synchronized by the input clock and electrically coded to the duobinary format. The output is a 3 level signal: a logical NRZ "0" input always gives an analog "0V" output, as a logical "1" input gives alternatively either "+V" or "-V" depending on the previous "1" state.

The different parts of the chip are internally biased using a voltage and currents reference circuit (Bandgap), in order to have the overall RF characteristics of the chip, insensitive to the voltage supply, the temperature and the process spread. An enable input control pin is used to switch the chip ON or OFF.

Three separate pins are used to bias the chip: one dedicated to the reference circuit, the second for the coder core (input buffers and coder core) and the last for the 50Ω output driver. The 3 bias inputs can be separately filtered / decoupled in order to optimize the overall chip performances.

Applications

- Duobinary TX
- Fiber transmission

Ordering information

Part Number: VWA 50029 AA

Main Features

- SiGe BiCMOS - Ft = 150GHz
- Data rate up to 25Gb/s
- 3 V / 480 mW typical bias @ 27°C
- Single or differential input / output
- Input amplitude (data and clock): 300mV pp
- Output amplitude: 800mV pp diff (400mV on each 50Ω output)
- Temperature compensated
- ON and OFF state through an enable pin control

Functional Block Diagram

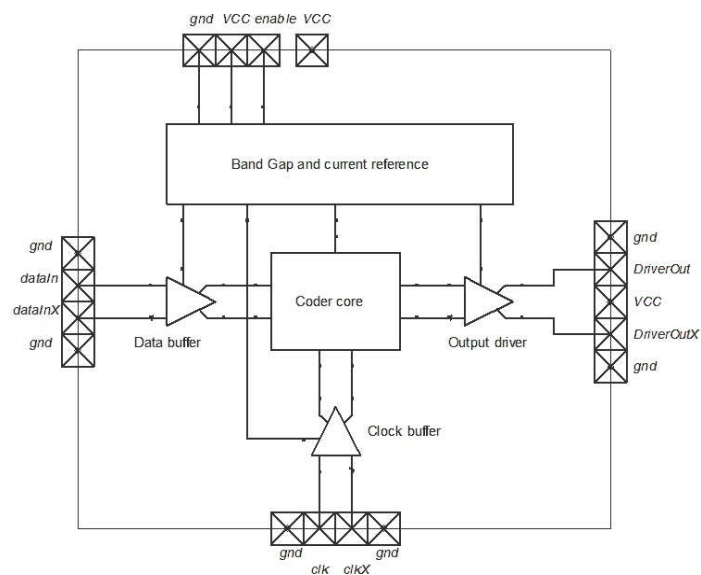

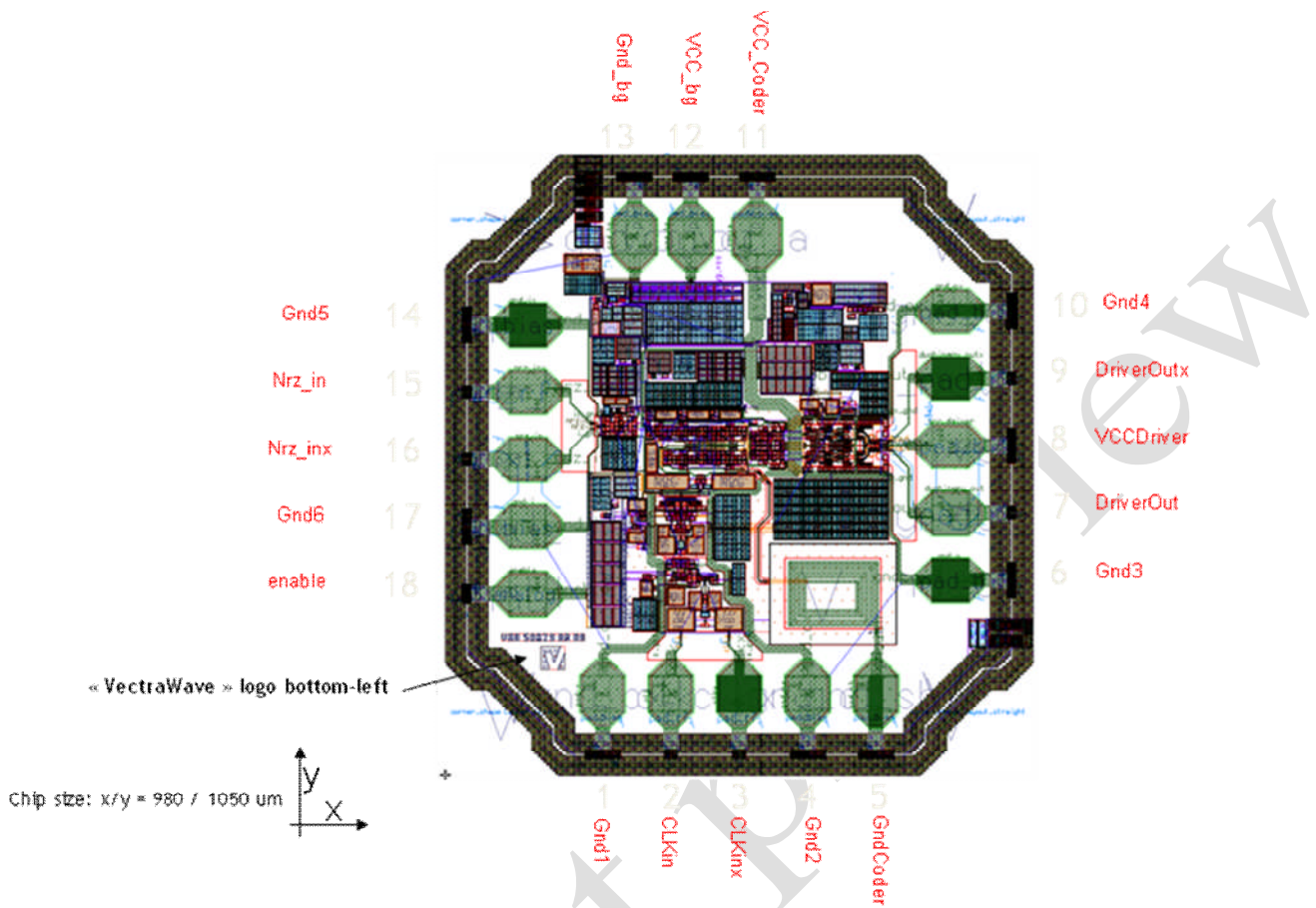

Chip pin out

Name	Type	Description
Gnd1*	Bias in/out	Ground for clock signal access. To be used with Gnd2 as ground plane for coplanar access.
CLKin	RF input	Clock signal input. Internally DC decoupled (no external series decoupling capacitor required). Is 100Ω differential with CLKinx
CLKinx	RF input	Complementary clock signal input. Internally DC decoupled (no external series decoupling capacitor required). Is 100Ω differential with CLKin.
Gnd2*	Bias in/out	Ground for clock signal access. To be used with Gnd1 as ground plane for coplanar access.
GndCoder	Bias in/out	Coder core ground access. Is in series with an integrated inductor used to filter the common mode signal due to switching. Can be grounded with an additional external inductor if needed.
Gnd3*	Bias in/out	Ground for signal driver output. To be used with Gnd4 as ground plane for coplanar access.
DriverOut	RF output	RF signal out. The driver uses a 50Ω resistor load in order to be consistent with 50Ω: has to be loaded if

Head Office : rue de la Croix Blanche - Immeuble LOGI – 78350 France

<http://www.vectrawave.com> ☎ + 33 (0)619 870 560 ☎ +33 (0)139 564 012

VWA 50029 AAAA DS Rev 0.31 VectraWave Proprietary information subject to change



光貿易株式会社

〒113-0034
東京都文京区湯島 3-13-8 湯島不二ビル 301 号
TEL : 03-3832-3117 FAX : 03-3832-3118
e-mail : contact@hikari-trading.com
<http://www.hikari-trading.com/>

		not used.
VCCDriver	Bias in/out	Positive bias for the driver output stage. The DC common output level to the output is directly dependent to this value.
DriverOutx	RF output	Complementary RF signal out. The driver uses a 50Ω resistor load in order to be consistant with 50Ω: has to be loaded if not used.
Gnd4*	Bias in/out	Ground for signal driver output. To be used with Gnd3 as ground plane for coplanar access.
VCC_Coder	Bias in/out	Main chip bias: biases the chip drivers, the coder core and the first driver stages.
VCC_bg	Bias in/out	Chip reference voltage and current bias. Is separated from the main bias to ensure a proper DC filtering
Gnd_bg	Bias in/out	Chip reference voltage and current ground. Is not physically connected to the RF grounds.
Gnd5*	Bias in/out	Ground for input signal access. To be used with Gnd6 as ground plane for coplanar access.
Nrz_in	RF input	Digital signal input. DC is present on the access. Has to be DC decoupled from the external source by an external capacitor. Is 100Ω differential referenced to Nrz_inx.
Nrz_inx	RF input	Complementary digital signal input. DC is present on the access. Has to be DC decoupled from the external source by an external capacitor. Is 100Ω differential referenced to Nrz_in.
Gnd6*	Bias in/out	Ground for input signal access. To be used with Gnd5 as ground plane for coplanar access.
enable	Digital input	Chip enable: switches the chip ON or OFF.

- All pads are octogonal (w / l μm²) = 66 / 105; except VCC_Coder = 75 / 105
- Die thickness = 0.28 mm (11 mils)
- No metallization on back side

Head Office : rue de la Croix Blanche - Immeuble LOGI – 78350 France

<http://www.vectrawave.com>

+33 (0)619 870 560

+33 (0)139 564 012

VWA 50029 AAAA DS Rev 0.31 VectraWave Proprietary information subject to change



光貿易株式会社

〒113-0034
東京都文京区湯島 3-13-8 湯島不二ビル 301号
TEL : 03-3832-3117 FAX : 03-3832-3118
e-mail : contact@hikari-trading.com
<http://www.hikari-trading.com/>

Electrical specifications

Electrical parameters	Conditions	Symbol	Min.	Typ.	Max.	Unit
<i>Chip bias</i>						
Supply voltage	VccCoder – VccBG	Vcc		3		V
	VccDriver		2.5	3	4	V
Current consumption OFF mode*	VccCoder; enable=0; T=27°C	VccCoder0		3		nA
	VccBG; enable=0; T=27°C	VccBG0	(100°C) 0.01	15	(-40°C) 28	uA
	VccDriver; enable=0; T=27°C	VccDriver0		27		pA
Current consumption ON mode*	VccCoder; enable=1	VccCoder1		160		mA
	VccBG; enable=1	VccBG1	(-40°C) 2		(100°C) 2.5	mA
	VccDriver; enable=1	VccDriver1		20		mA
<i>Data input (Nrz_in and Nrz_inx)</i>						
Input impedance	Single and differential modes	Zin		100		Ω
Amplitude range**	Single or differential input		2	300		mVpp
<i>Clock input (Clkin and Clkinx)</i>						
Input impedance	Single and differential modes			100		Ω
Amplitude range**	Single or differential input		1	300		mVpp
Frequency range***					25	GHz
Phase margin				Tbit/4		
<i>Driver Output</i>						
Output impedance	Single / Differential			50 / 100		Ω

Head Office : rue de la Croix Blanche - Immeuble LOGI – 78350 France

<http://www.vectrawave.com>

+33 (0)619 870 560

+33 (0)139 564 012

VWA 50029 AAAA DS Rev 0.31

VectraWave Proprietary information subject to change



光 賀 易 株 式 会 社

〒113-0034

東京都文京区湯島 3-13-8 湯島不二ビル 301号

TEL : 03-3832-3117 FAX : 03-3832-3118

e-mail : contact@hikari-trading.com

<http://www.hikari-trading.com/>

Common mode voltage	Referred to VCCDriver			VCCDriver-0.350		V
Amplitude	Single			400		mVpp

* OFF → enable =“0”, ON → enable=“1”

** The Min value corresponds to the sensitivity.

*** The frequency range is given in GHz for the clock signal. It corresponds to the data rate.

Product preview

Head Office : rue de la Croix Blanche - Immeuble LOGI – 78350 France

<http://www.vectrawave.com> ☎ + 33 (0)619 870 560 ☎ +33 (0)139 564 012

VWA 50029 AAAA DS Rev 0.31 VectraWave Proprietary information subject to change



光貿易株式会社

〒113-0034
東京都文京区湯島 3-13-8 湯島不二ビル 301 号
TEL : 03-3832-3117 FAX : 03-3832-3118
e-mail : contact@hikari-trading.com
<http://www.hikari-trading.com/>

Absolute rating

Parameters	Conditions	Symbol	Min.	Typ.	Max.	Unit
Supply voltage	VccCoder – VccBG - VccDriver	Vcc	-0.5		4.6	V
Digital input	enable		-0.5		4.6	V
Storage temperature					TBC	°C

ESD protection

Parameters	Conditions	Symbol	Min.	Typ.	Max.	Unit
HBM* rating RF in/out	Clk, NRZin DriverOut				0.9	kV
HBM* rating analog	enable				2.3	kV
HBM* rating bias	VCC gnd				5.7	kV

*Human Body Model

Head Office : rue de la Croix Blanche - Immeuble LOGI – 78350 France

<http://www.vectrawave.com> ☎ + 33 (0)619 870 560 ☎ +33 (0)139 564 012

VWA 50029 AAAA DS Rev 0.31 VectraWave Proprietary information subject to change



光貿易株式会社

〒113-0034
東京都文京区湯島 3-13-8 湯島不二ビル 301 号
TEL : 03-3832-3117 FAX : 03-3832-3118
e-mail : contact@hikari-trading.com
<http://www.hikari-trading.com/>

Application schematic

Differential IN and OUT

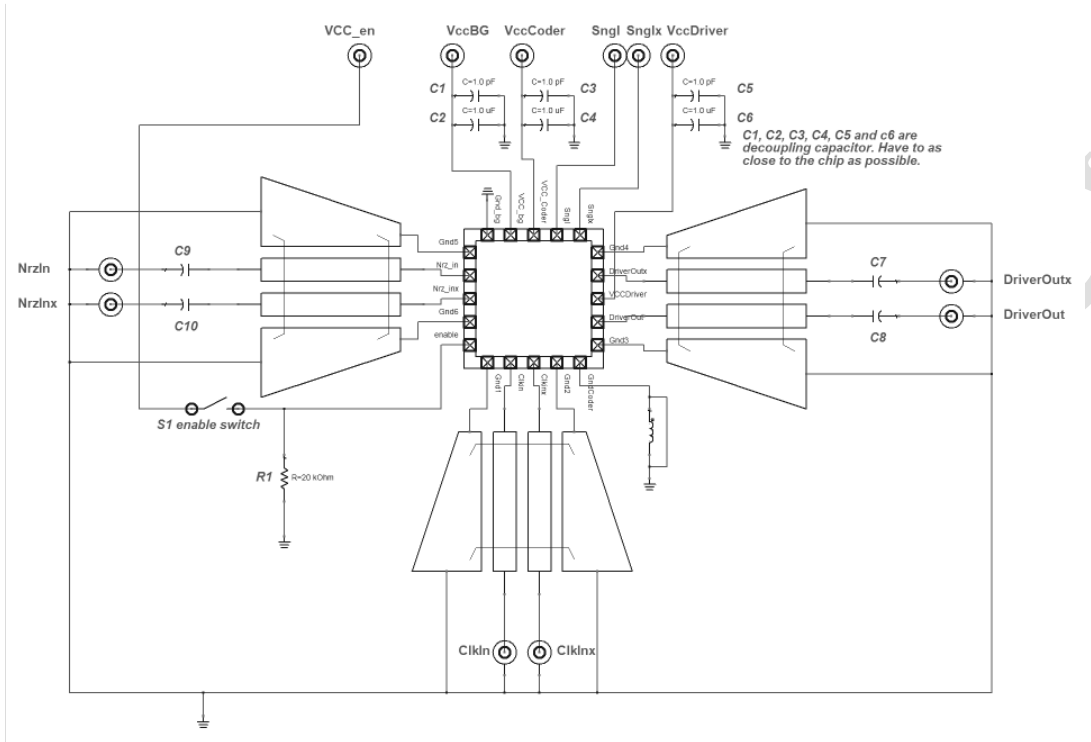

Single-ended IN and OUT

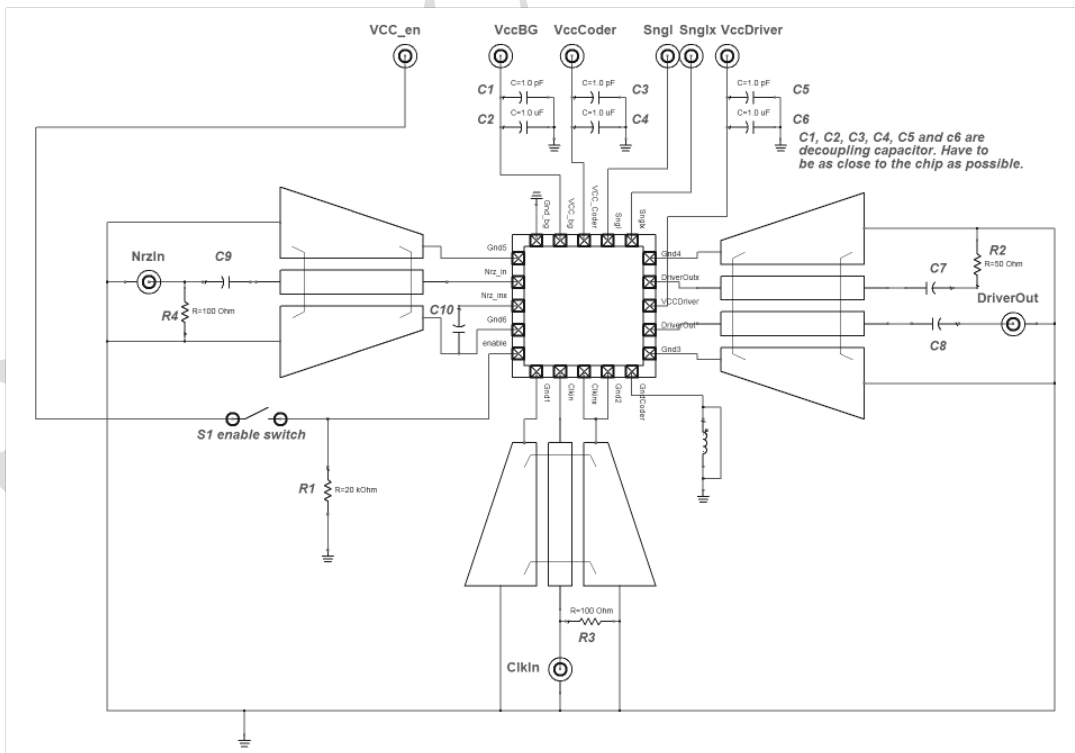

Head Office : rue de la Croix Blanche - Immeuble LOGI – 78350 France

<http://www.vectrawave.com> ☎ + 33 (0)619 870 560 ☎ +33 (0)139 564 012

VWA 50029 AAAA DS Rev 0.31 VectraWave Proprietary information subject to change



光貿易株式会社

〒113-0034
東京都文京区湯島 3-13-8 湯島不二ビル 301 号
TEL : 03-3832-3117 FAX : 03-3832-3118
e-mail : contact@hikari-trading.com
<http://www.hikari-trading.com/>

Output characteristics - simulated

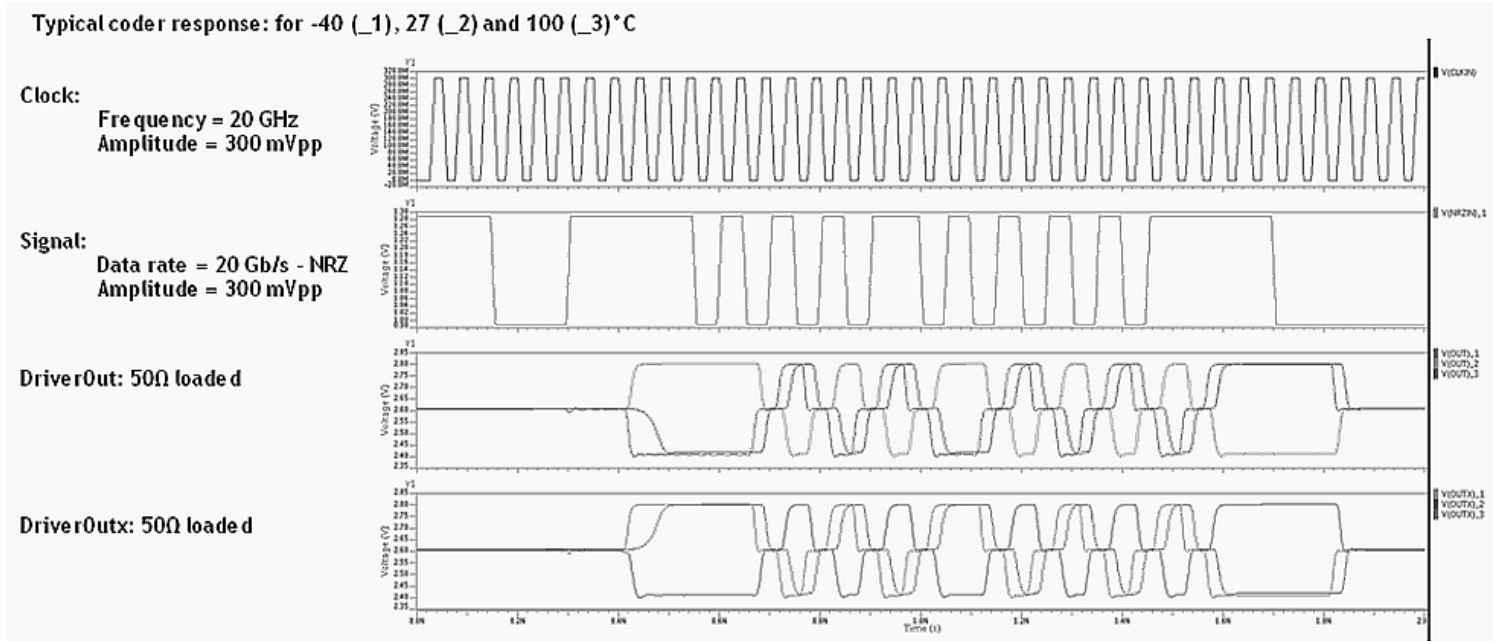

Eye diagram measurement @12.5Gbps

Measurement conditions: single-ended IN and OUT, measured directly to the chip output

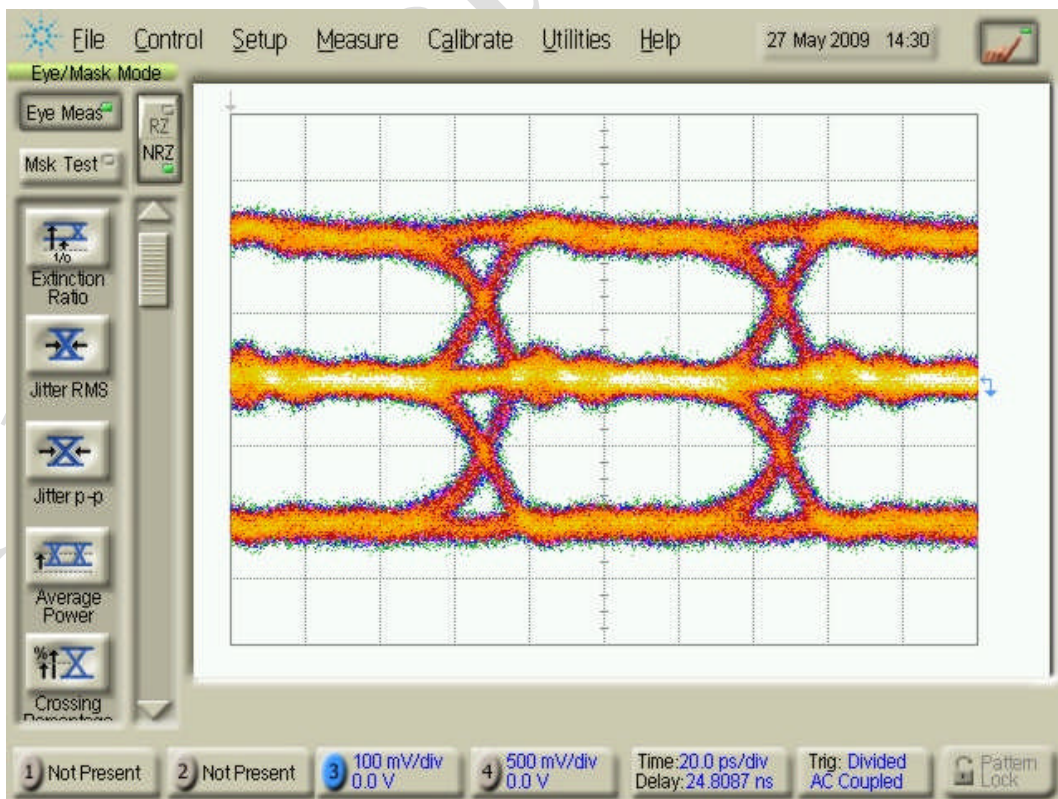

Head Office : rue de la Croix Blanche - Immeuble LOGI – 78350 France

<http://www.vectrawave.com> ☎ + 33 (0)619 870 560 ☎ +33 (0)139 564 012

VWA 50029 AAAA DS Rev 0.31 VectraWave Proprietary information subject to change



光貿易株式会社

〒113-0034
 東京都文京区湯島 3-13-8 湯島不二ビル 301 号
 TEL : 03-3832-3117 FAX : 03-3832-3118
 e-mail : contact@hikari-trading.com
<http://www.hikari-trading.com/>

Measurement conditions: single-ended IN and OUT, measured after driver

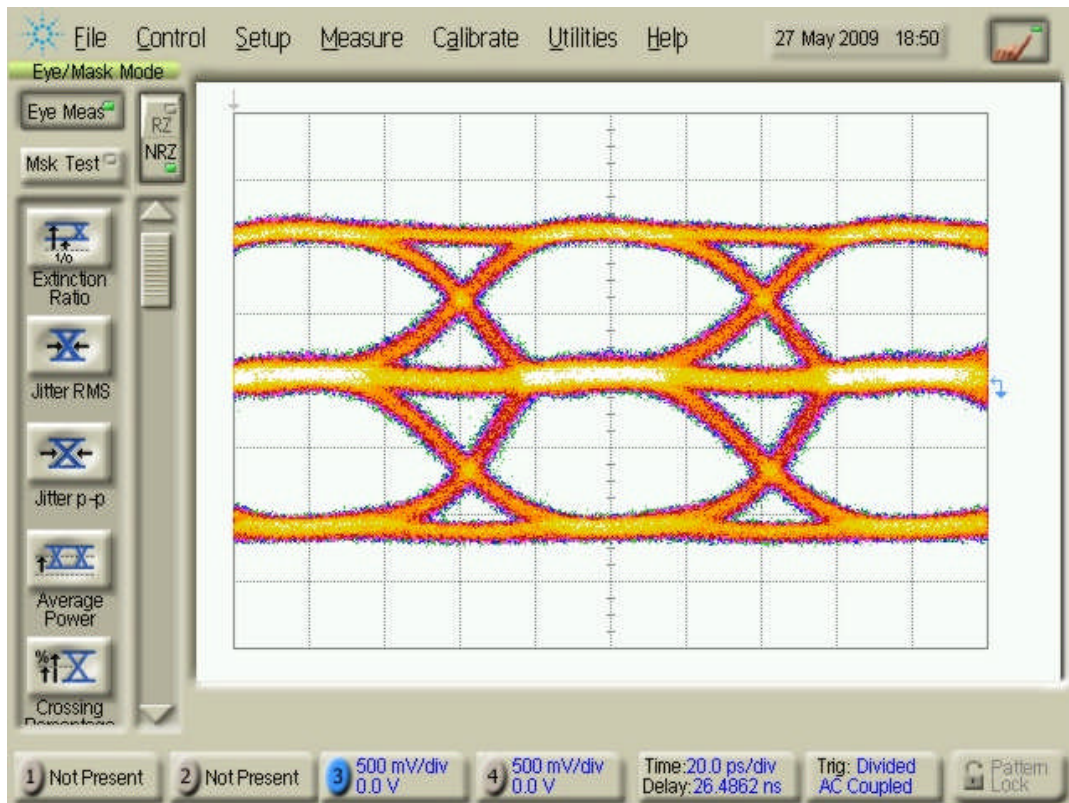

Handling



These products are sensitive to electrostatic discharge and should not be handled except at a static free workstation. Take precautions to prevent ESD; use wrist straps, grounded work surfaces and recognized anti-static techniques when handling the IC.

Head Office : rue de la Croix Blanche - Immeuble LOGI - 78350 France

<http://www.vectrawave.com> ☎ + 33 (0)619 870 560 ☎ +33 (0)139 564 012

VWA 50029 AAAA DS Rev 0.31 VectraWave Proprietary information subject to change



光貿易株式会社

〒113-0034
東京都文京区湯島 3-13-8 湯島不二ビル 301 号
TEL : 03-3832-3117 FAX : 03-3832-3118
e-mail : contact@hikari-trading.com
<http://www.hikari-trading.com/>