



FEATURES

- Superior Extinction ratio : > 30 dB
- High Bandwidth (> 12 GHz)
- X-cut for high stability
- Low drive voltage
- Low insertion loss

APPLICATIONS

- Pulse generation / picking
- Carrier suppression
- Fiber optics sensors
- Pulse applications
- Analog transmission

OPTIONS

- 20 GHz version
- 1550 nm, 1300 nm band versions
- Choice of optical connectors

RELATED EQUIPMENTS

- RF amplifiers
- MBC-DG Automatic Bias Controllers

The NIR-MX-LN-10 is an intensity modulator especially designed for operation in the 1000 nm wavelength band.

This Mach-Zehnder modulator offers engineers working at 1000 nm the intrinsic and unparalleled benefits of LiNbO₃ external modulation : high bandwidth, high contrast up to 30 dB and beyond, ease of use. Thanks to Photline Technologies proprietary waveguide process, the NIR-MX-LN-10 exhibits a stable behaviour and supports several tens mW of input optical power.

Performance Highlights

Parameter	Min	Typ	Max	Unit
Operating wavelength	980	-	1150	nm
Insertion loss	-	5	-	dB
Extinction ratio	-	30	-	dB
Electro-optical bandwidth	-	12	-	GHz
V π RF @50 kHz	-	4	-	V
Electrical return loss	-	12	-	dB

Specifications given at 25 °C, 1060 nm

Extinction Ratio Response

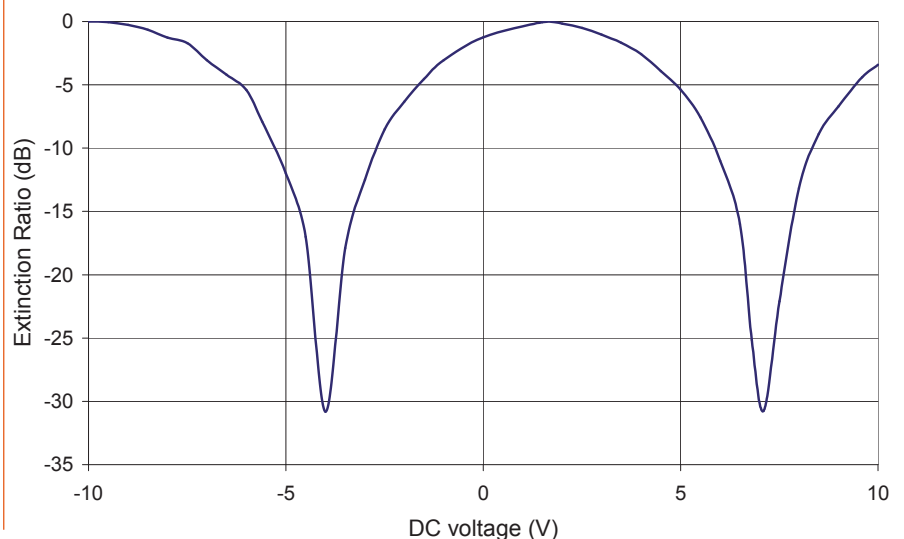

Electrical Characteristics

Parameter	Symbol	Condition	Min	Typ	Max	Unit
Electro-optic bandwidth	S_{21}	RF electrodes, from 2 GHz	10	12	-	GHz
Ripple S21	ΔS_{21}	RF electrodes, $f < 12\text{GHz}$	-	0.5	1	dB
Electrical return loss	ES_{11}	RF electrodes	-	-12	-10	dB
$V\pi$ RF @50 kHz	$V\pi_{RF_{50\text{kHz}}}$	RF electrodes	-	4	4.5	V
$V\pi$ DC electrodes	$V\pi_{DC}$	DC electrodes	-	5	6	V
RF input impedance	Z_{in-RF}	-	-	40	-	Ω
DC input impedance	Z_{in-DC}	-	-	1	-	M Ω

Optical Characteristics All specifications given at 25°C, 1060 nm, unless differently specified

Parameter	Symbol	Condition	Min	Typ	Max	Unit
Crystal	-	-	Lithium Niobate X-Cut Y-Prop			
Operating wavelength	λ	-	980	1060	1150	nm
Insertion loss	IL	Without connectors	-	5	5.5	dB
DC extinction ratio	ER > 20	Measured with narrow source linewidth < 200 MHz	20	-	-	dB
	ER > 25		25	-	-	dB
	ER > 30		30	-	-	dB
Optical return loss	ORL	-	-40	-45	-	dB
Chirp	α	-	-0.1	0	0.1	-

Absolute Maximum Ratings

Stresses in excess of the absolute maximum ratings can cause permanent damage to the device. These are absolute stress ratings only. Functional operation of the device is not implied at these or any other conditions in excess of those given in the operational sections of the data sheet. Exposure to absolute maximum ratings for extended periods can adversely affect device reliability.

Parameter	Symbol	Min	Max	Unit
RF input power	EP_{in}	-	28	dBm
Bias voltage	V_{bias}	-20	+20	V
Optical input power	OP_{in}	-	20	dBm
Operating temperature	OT	0	+70	°C
Storage temperature	ST	-40	+85	°C

S21 & S11 Parameter Curves at RF input port

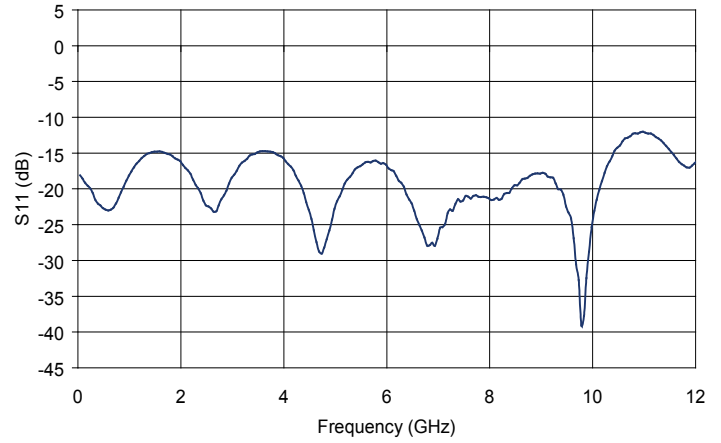
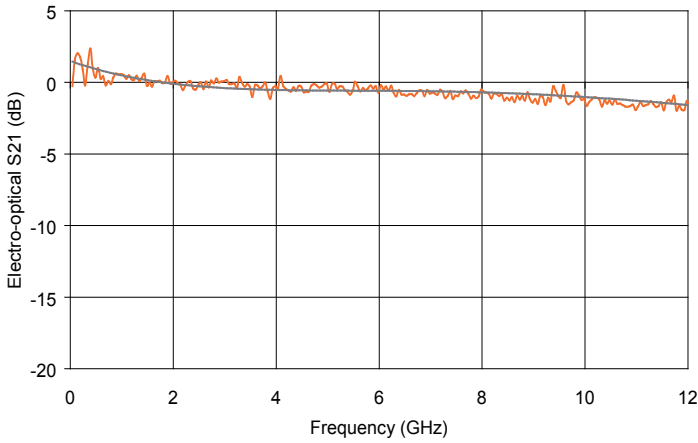

100 ps pulse generated

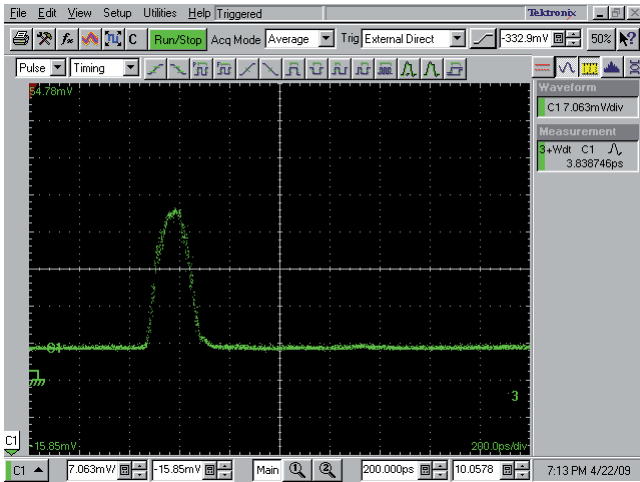

100 ns pulse generated

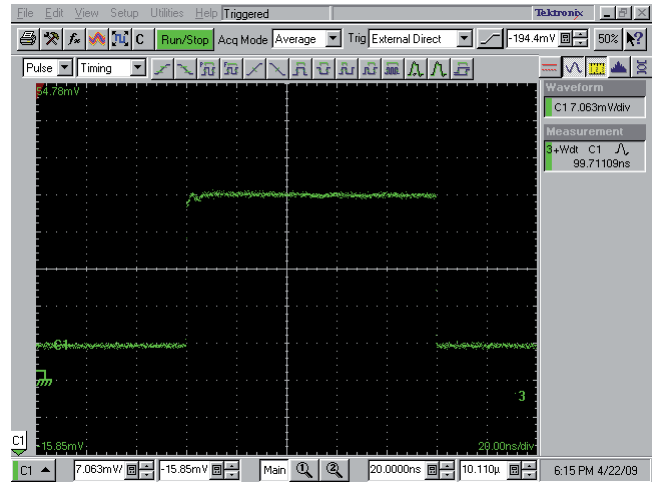

Extinction Ratio

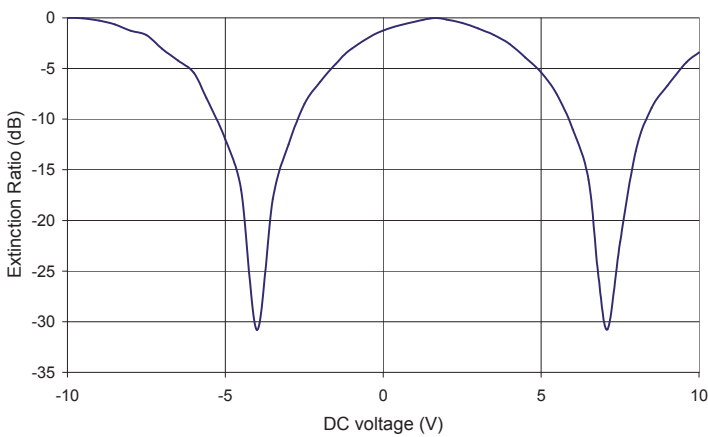

Stability with Time and Temperature

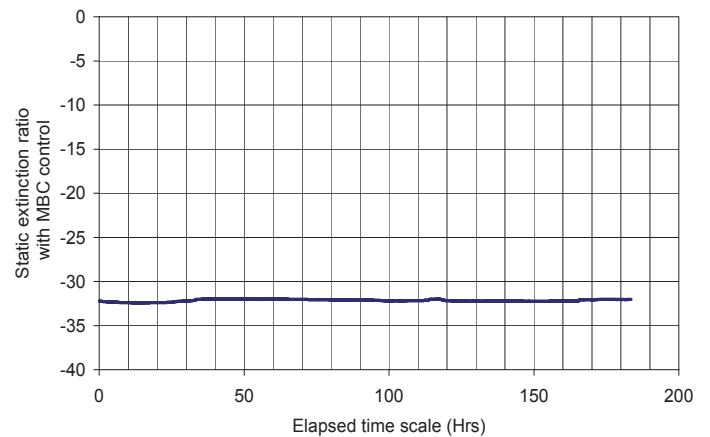

Mechanical Diagram and pinout All measurements in mm

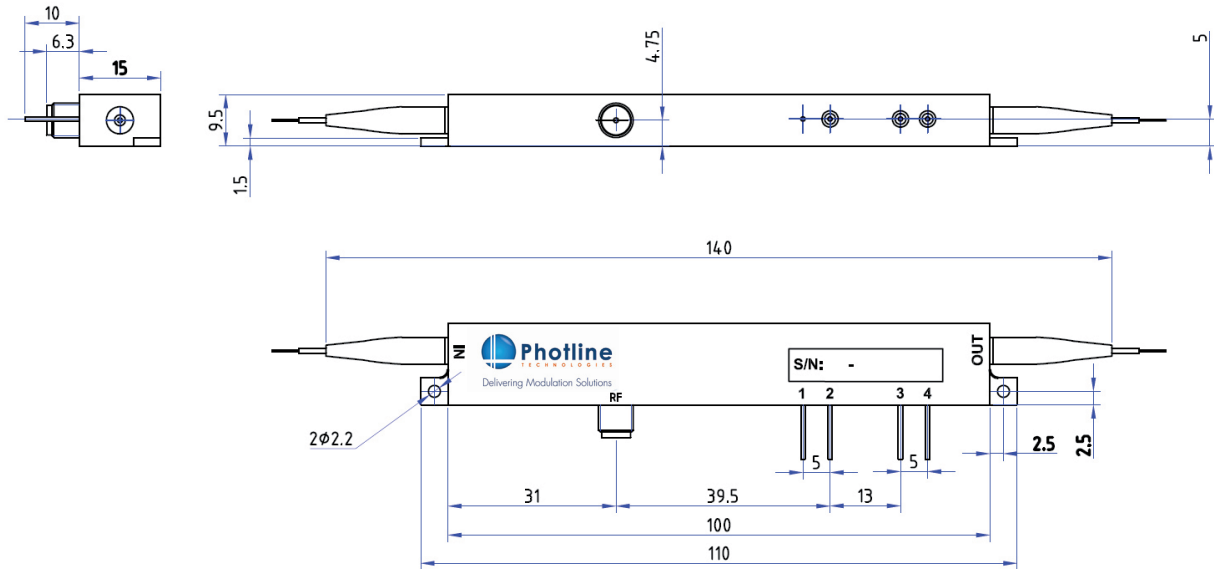

Port	Function	Note
IN	Optical input port	Polarization maintaining fiber, Corning PM 98-U25A, Length 1.5 meter. Buffer diameter 900 μ m
OUT	Optical output port	Polarization maintaining fiber, Corning PM 98-U25A, Length 1.5 meter. Buffer diameter 900 μ m
RF	RF input port	Wiltron female K
1	Ground	Pin feed through diameter 1.0 mm
2	DC	Pin feed through diameter 1.0 mm
3	Photodiode cathode	Pin feed through diameter 1.0 mm
4	Photodiode anode	Pin feed through diameter 1.0 mm

Ordering information

NIR-MX-LN-BW-XX-Y-Z-AB-CD-xxdB

BW = Bandwidth : 10 10 GHz 20 20 GHz

XX = Internal photodiode : 00 Not integrated PD PD Integrated

Y = Input fiber : P Polarisation maintaining S Standard single mode

Z = Input fiber : P Polarisation maintaining S Standard single mode

AB = Output connector : 00 bare fiber FA FC/APC FC FC/SPC

CD = Output connector : 00 bare fiber FA FC/APC FC FC/SPC

Note : optical connectors are Seikoh-Giken with narrow key or equivalent

xxdB = Extinction ratio : 20 20 dB 25 25dB 30 30dB

Related equipments

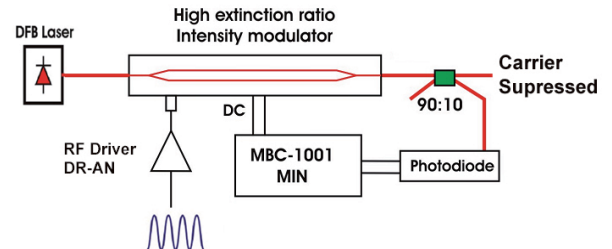
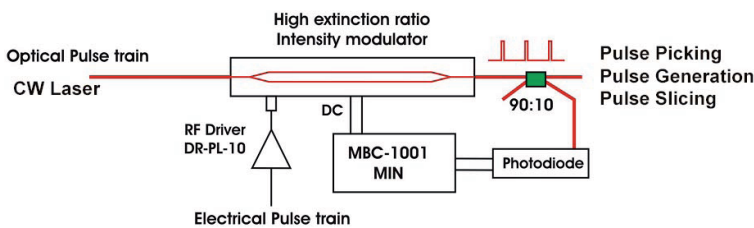

Pulse Generation / Picking / Slicing

DR-PL amplifiers series are intended to drive NIR-MX-LN as to generate undistorted optical pulses.

MBC-DG-BT is an automatic bias controller designed to lock the operating point of the NIR-MX-LN modulators. MBC-DG-BT achieves an extinction ratio up to 50 dB with the proper modulator.



Carrier suppressed / Analog modulation

DR-AN amplifiers series are a wideband RF amplifiers modules designed for analog applications at frequencies up to 40 GHz.

MBC-DG-BT is an automatic bias controller designed to lock the operating point of the NIR-MX-LN modulators.



Modbox-Pulse Modboxes are a family of turnkey optical transmitters and external benchtop units for pulse and other specific applications.

Pulse Generation / Pulse Picking / Slicing ModBoxes are Optical Modulation Units designed to generate controlled optical pulses.

About us

Photline Technologies is a provider of Fiber Optics Modulation Solutions based on the company LiNbO₃ modulators and high-speed electronics modules. Photline Technologies offers high speed and high data rate modulation solutions for the telecommunication industry and the defense, aerospace, instruments and sensors markets. The products offered by the company include : comprehensive range of intensity and phase modulators (800 nm, 1060 nm, 1300 nm, 1550 nm, 2000 nm), RF drivers and modules, transmitters and modulation units.