

## FEATURES

- High bandwidth
- X-cut for high stability
- Low drive voltage
- Low insertion loss

## APPLICATIONS

- Digital communications
- General purpose intensity modulation
- Test and measurement

## OPTIONS

- High extinction ratio versions
- 2000 nm, 1300 nm, 1060 nm, 850 nm

## RELATED EQUIPMENTS

- RF amplifiers
- MBC-DG Automatic Bias Controllers
- ModBox-1550nm-44Gb/s-NRZ

The Photline MX-LN series are lithium niobate (LiNbO<sub>3</sub>) intensity modulators designed for optical communications at data rates up to 44 Gb/s.

The X-cut design of these Mach-Zehnder modulators confer them an unmatched stability in a wide range of operational conditions, as well as a zero chirp performance. Ixblue proprietary waveguide design offers a low insertion loss combined with a high contrast. The MX-LN series are ideally suited for 10 Gb/s up to Gb/s optical transmission with NRZ, RZ, DPSK, Duo Binary modulation formats and are key device for a large variety of high bandwidth applications.

## MX-LN-10 Performance Highlights

Parameter	Min	Typ	Max	Unit
Operating wavelength	1530	-	1625	nm
Insertion loss (option low IL)	-	2.7	-	dB
Electro-optical bandwidth	-	12	-	GHz
V <sub>p</sub> RF @50 kHz	-	5	5.5	V

Specifications given at 25 °C, 1550 nm

## MX-LN-20 Performance Highlights

Parameter	Min	Typ	Max	Unit
Operating wavelength	1530	-	1625	nm
Insertion loss (option low IL)	-	2.7	-	dB
Electro-optical bandwidth	-	25	-	GHz
V <sub>p</sub> RF @50 kHz	-	5	-	V

Specifications given at 25 °C, 1550 nm

## MX-LN-40 Performance Highlights

Parameter	Min	Typ	Max	Unit
Operating wavelength	1530	-	1625	nm
Insertion loss	-	4	-	dB
Electro-optical bandwidth	-	30	-	GHz
V <sub>p</sub> RF @50 kHz	-	5	-	V

Specifications given at 25 °C, 1550 nm

## MX-LN-10

### 10 GHz Intensity modulator

#### Electrical Characteristics

Parameter	Symbol	Condition	Min	Typ	Max	Unit
Electro-optic bandwidth	$S_{21}$	RF electrodes, from 2 GHz	10	12	-	GHz
Ripple $S_{21}$	$DS_{21}$	RF electrodes, $f < 12$ GHz	-	0.5	1	dB
Electrical return loss	$S_{11}$	RF electrodes	-	-12	-10	dB
Vp RF @50 kHz	$V_{pRF_{50\text{ kHz}}}$	RF electrodes, @1550 nm	-	5	5.5	V
Vp RF @10 Gb/s PRBS	$V_{pRF_{10\text{ Gb/s}}}$	RF electrodes, @1550 nm	-	6.5	7	V
Vp DC electrodes	$V_{pDC}$	DC electrodes	-	4	5	V
RF input impedance	$Z_{in-RF}$	-	-	50	-	$\Omega$
DC input impedance	$Z_{in-DC}$	-	-	1	-	MW

50  $\Omega$  RF input

#### Optical Characteristics

Parameter	Symbol	Condition	Min	Typ	Max	Unit
Crystal	-	-	Lithium Niobate X-Cut Y-Prop			
Operating wavelength	$\lambda$	-	1530	1550	1625	nm
Insertion loss	IL	Without connectors	-	3.5	4.5	dB
		Option Low IL, without connectors	-	2.7	3	dB
DC extinction ratio	ER	Measured with narrow source linewidth $< 200$ MHz	20	22	-	dB
Optical return loss	ORL	-	-40	-45	-	dB
Chirp	$a$	-	-0.1	0	0.1	-

All specifications given at 25°C, 1550 nm, unless differently specified

#### Absolute Maximum Ratings

Stresses in excess of the absolute maximum ratings can cause permanent damage to the device. These are absolute stress ratings only. Functional operation of the device is not implied at these or any other conditions in excess of those given in the operational sections of the data sheet. Exposure to absolute maximum ratings for extended periods can adversely affect device reliability.

Parameter	Symbol	Min	Max	Unit
RF input power	$EP_{in}$	-	26	dBm
Bias voltage	$V_{bias}$	-20	+20	V
Optical input power	$OP_{in}$	-	20	dBm
Operating temperature	OT	0	+70	°C
Storage temperature	ST	-40	+85	°C

## MX-LN-20

### 20 GHz Intensity modulator

#### Electrical Characteristics

Parameter	Symbol	Condition	Min	Typ	Max	Unit
Electro-optic bandwidth	$S_{21}$	RF electrodes, from 2 GHz	20	25	-	GHz
Ripple $S_{21}$	$DS_{21}$	RF electrodes, $f < 20$ GHz	-	0.5	1	dB
Electrical return loss	$S_{11}$	RF electrodes	-	-12	-10	dB
Vp RF @50 kHz	$V_{pRF_{50\text{ kHz}}}$	RF electrodes, @1550 nm	-	5	5.5	V
Vp RF @20 Gb/s PRBS	$V_{pRF_{20\text{ Gb/s}}}$	RF electrodes, @1550 nm	-	5.5	6	V
Vp DC electrodes	$V_{pDC}$	DC electrodes	-	6.5	7	V
RF input impedance	$Z_{in-RF}$	-	-	50	-	W
DC input impedance	$Z_{in-DC}$	-	-	1	-	MW

50 W RF input

#### Optical Characteristics

Parameter	Symbol	Condition	Min	Typ	Max	Unit
Crystal	-	-	Lithium Niobate X-Cut Y-Prop			
Operating wavelength	$\lambda$	-	1530	1550	1625	nm
Insertion loss	IL	Without connectors	-	3.5	4.5	dB
		Option Low IL, without connectors	-	2.7	3	dB
DC extinction ratio	ER	Measured with narrow source linewidth $< 200$ MHz	20	22	-	dB
Optical return loss	ORL	-	-40	-45	-	dB
Chirp	$a$	-	-0.1	0	0.1	-

All specifications given at 25 °C, 1550 nm, unless different specified

#### Absolute Maximum Ratings

Stresses in excess of the absolute maximum ratings can cause permanent damage to the device. These are absolute stress ratings only. Functional operation of the device is not implied at these or any other conditions in excess of those given in the operational sections of the data sheet. Exposure to absolute maximum ratings for extended periods can adversely affect device reliability.

Parameter	Symbol	Min	Max	Unit
RF input power	$EP_{in}$	-	28	dBm
Bias voltage	$V_{bias}$	-20	+20	V
Optical input power	$OP_{in}$	-	20	dBm
Operating temperature	OT	0	+70	°C
Storage temperature	ST	-40	+85	°C

## MX-LN-40

### 40 GHz Intensity modulator

#### Electrical Characteristics

Parameter	Symbol	Condition	Min	Typ	Max	Unit
Electro-optic bandwidth	$S_{21}$	RF electrodes, from 2 GHz	28	30	-	GHz
Ripple $S_{21}$	$DS_{21}$	RF electrodes, $f < 30$ GHz	-	0.5	1	dB
Electrical return loss	$S_{11}$	RF electrodes	-	-12	-10	dB
Vp RF @50 kHz	$V_{pRF_{50\text{ kHz}}}$	RF electrodes, @1550 nm	-	5	6	V
Vp DC electrodes	$V_{pDC}$	DC electrodes, @1550 nm	-	6.5	7	V
RF input impedance	$Z_{in-RF}$	-	-	50	-	$\Omega$
DC input impedance	$Z_{in-DC}$	-	1	-	-	MW

50  $\Omega$  RF input

#### Optical Characteristics

Parameter	Symbol	Condition	Min	Typ	Max	Unit
Crystal	-	-	Lithium Niobate X-Cut Y-Prop			
Operating wavelength	$\lambda$	-	1530	1550	1625	nm
Insertion loss	IL	Without connectors	-	3.5	4.5	dB
DC extinction ratio	ER	Measured with narrow source linewidth < 200 MHz	20	22	-	dB
Optical return loss	ORL	-	-40	-45	-	dB
Chirp	$a$	-	-0.1	0	0.1	-

All specifications given at 25 °C, 1550 nm, unless different specified

#### Absolute Maximum Ratings

Stresses in excess of the absolute maximum ratings can cause permanent damage to the device. These are absolute stress ratings only. Functional operation of the device is not implied at these or any other conditions in excess of those given in the operational sections of the data sheet. Exposure to absolute maximum ratings for extended periods can adversely affect device reliability.

Parameter	Symbol	Min	Max	Unit
RF input power	$EP_{in}$	-	28	dBm
Bias voltage	$V_{bias}$	-20	+20	V
Optical input power	$OP_{in}$	-	20	dBm
Operating temperature	OT	0	+70	°C
Storage temperature	ST	-40	+85	°C

MX-LN-10 Typical  $S_{21}$  Curve

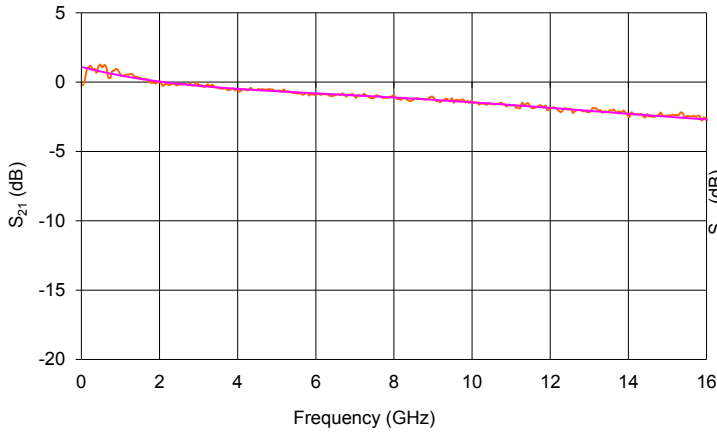

MX-LN-10 Typical  $S_{11}$  Curve

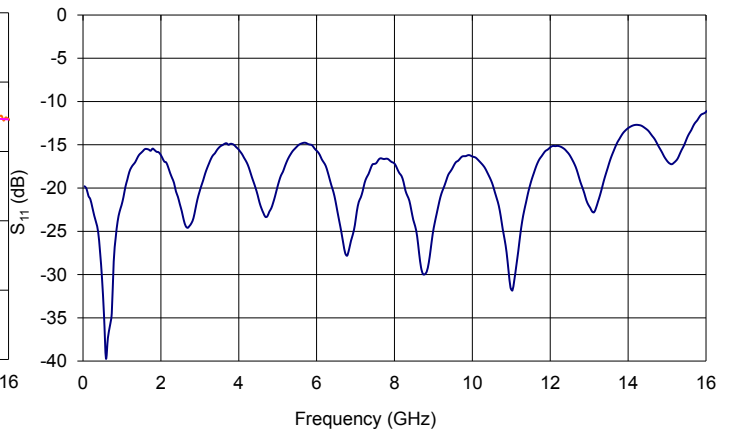

MX-LN-20 Typical  $S_{21}$  Curve

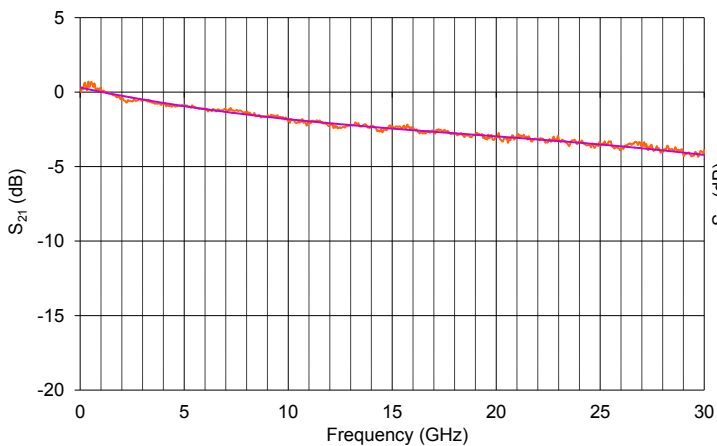

MX-LN-20 Typical  $S_{11}$  Curve

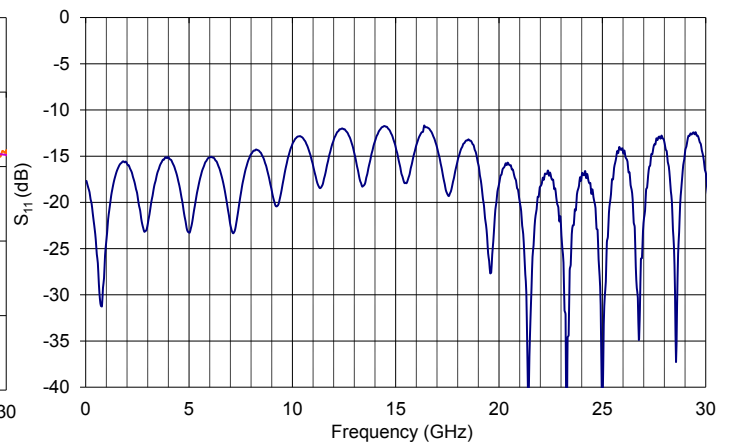

MX-LN-40 Typical  $S_{21}$  Curve

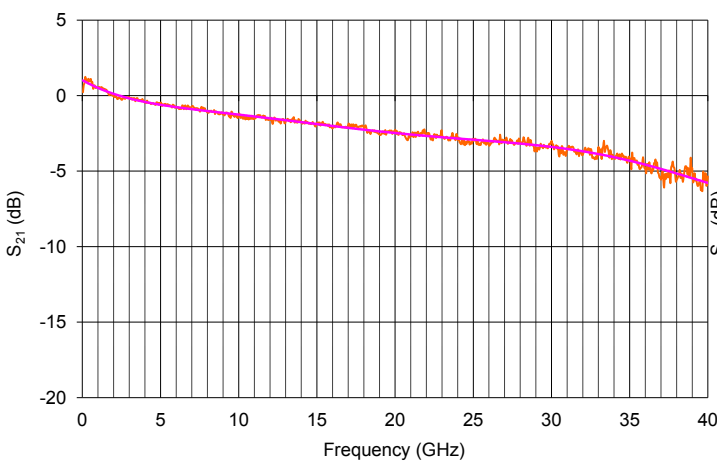

MX-LN-40 Typical  $S_{11}$  Curve

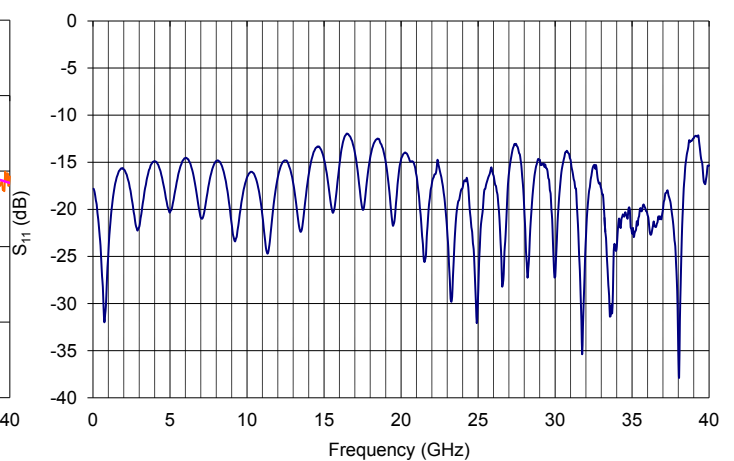

### Mechanical Diagram and Pinout

All measurements in mm

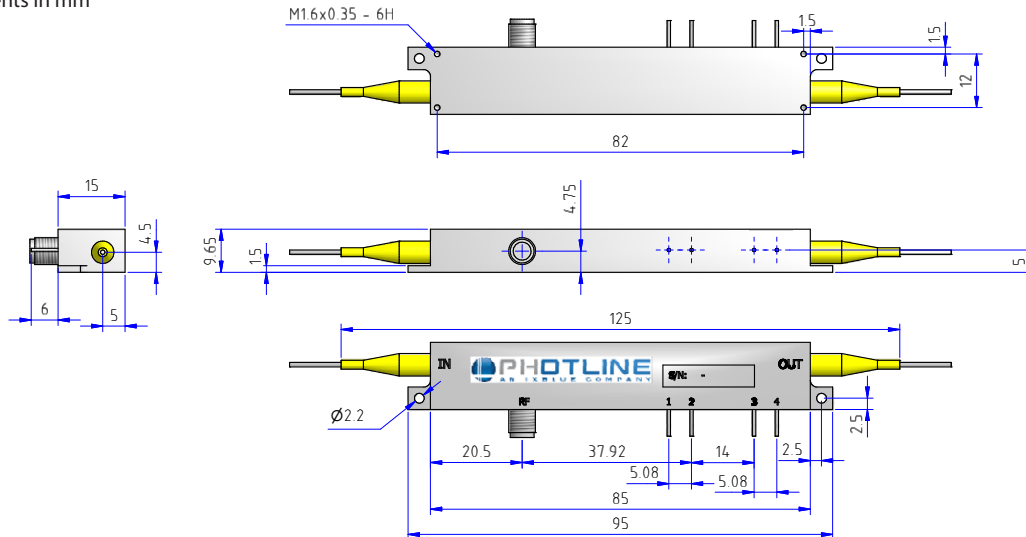

Port	Function	Note
IN	Optical input port	Polarization maintaining fiber, Corning PM 15-U25D, Length 1.5 meter. Buffer diameter 900 mm
OUT	Optical output port	Polarization maintaining fiber, Corning PM 15-U25D, Length 1.5 meter. Buffer diameter 900 mm
RF	RF input port	MX-LN-10: Wiltron female K (SMA compatible) MX-LN-20: Wiltron female K or V (optional) MX-LN-40: Wiltron female V
1	Ground	Pin feed through diameter 1.0 mm
2	DC	Pin feed through diameter 1.0 mm
3, 4	Photodiode cathode, anode	Pin feed through diameter 1.0 mm

### Ordering information

#### MX-LN-BW-XX-Y-Z-AB-CD

BW = Bandwidth : 10 10 GHz 20 20 GHz 40 40 GHz  
 XX = Internal photodiode : 00 Not integrated PD PD Integrated  
 Y = Input fiber : P Polarization maintaining S Standard single mode  
 Z = Output fiber : P Polarization maintaining S Standard single mode  
 AB = Input connector : 00 bare fiber FA FC/APC FC FC/SPC  
 CD = Output connector : 00 bare fiber FA FC/APC FC FC/SPC  
 Note : optical connectors are Seikoh-Giken with narrow key or equivalent

### About us

iXBlue Photonics includes iXBlue iXBlue brand that produces specialty optical fibers and Bragg gratings based fiber optics components and iXBlue Photline brand that provides optical modulation solutions based on the company lithium niobate (LiNbO<sub>3</sub>) modulators and RF electronic modules.

iXBlue Photonics serves a wide range of industries: sensing and instruments, defense, telecommunications, space and fiber lasers as well as research laboratories all over the world.

3, rue Sophie Germain  
 25 000 Besançon - FRANCE  
 Tel. : +33 (0) 381 853 180 - Fax : + 33 (0) 381 811 557

Ixblue reserves the right to change, at any time and without notice, the specifications, design, function or form of its products described herein. All statements, specification, technical information related to the products herein are given in good faith and based upon information believed to be reliable and accurate at the moment of printing. However the accuracy and completeness thereof is not guaranteed. No liability is assumed for any inaccuracies and as a result of use of the products. The user must validate all parameters for each application before use and he assumes all risks in connection with the use of the products